

MECHANICAL INSTALLATION

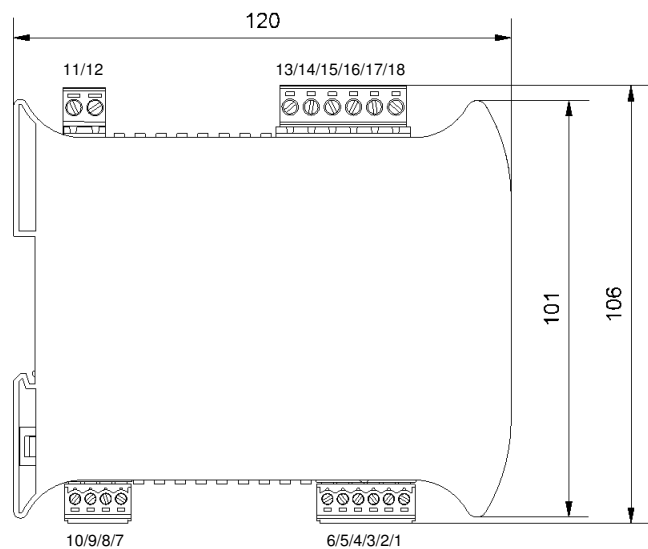

MOUNTING

1 Screwdriver



2 EN60715 DIN RAIL

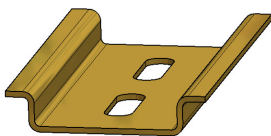

Enclosure

Style DIN Rail Mount
Material Blend PC/ABS self extinguishing
Terminals Screw terminal
Cable 2.5 mm Max
Colour Grey

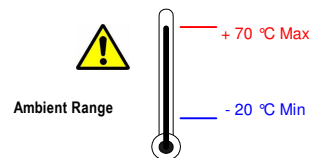
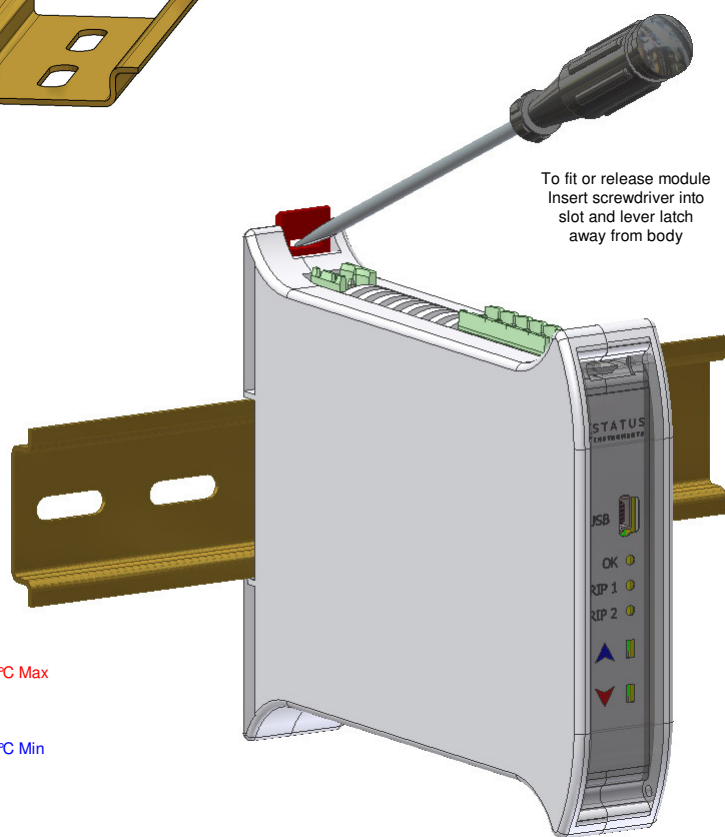

All Dimensions in mm

ELECTRICAL INSTALLATION

TURN OFF SUPPLY BEFORE WORKING ON ANY ELECTRICAL CONNECTION



INPUT CONNECTION
For cable length < 3 Metres no screen or twisted pair required.
Thermocouple inputs must use correct compensation cable.
PT100 inputs all three wires must be equal length (resistance).
Max input cable length 30 metres.

ANALOGUE OUTPUT CONNECTION
For cable length < 3 metres no screen or twisted pair required.
Use twisted pair or screened for current output (3 to 1000) metres.
Voltage output use screened cables (3 to 30) metres, cable lengths > 30 metres not advised.

TRIP OUTPUT CONNECTION
Trip outputs are isolated from each other.
Max switching current (1 A @ 240 V ac, 1 A @ 30 V dc)
Non Inductive

SUPPLY CONNECTION
Supply input is not polarity sensitive.
Max supply 240 V ac or 240 V dc

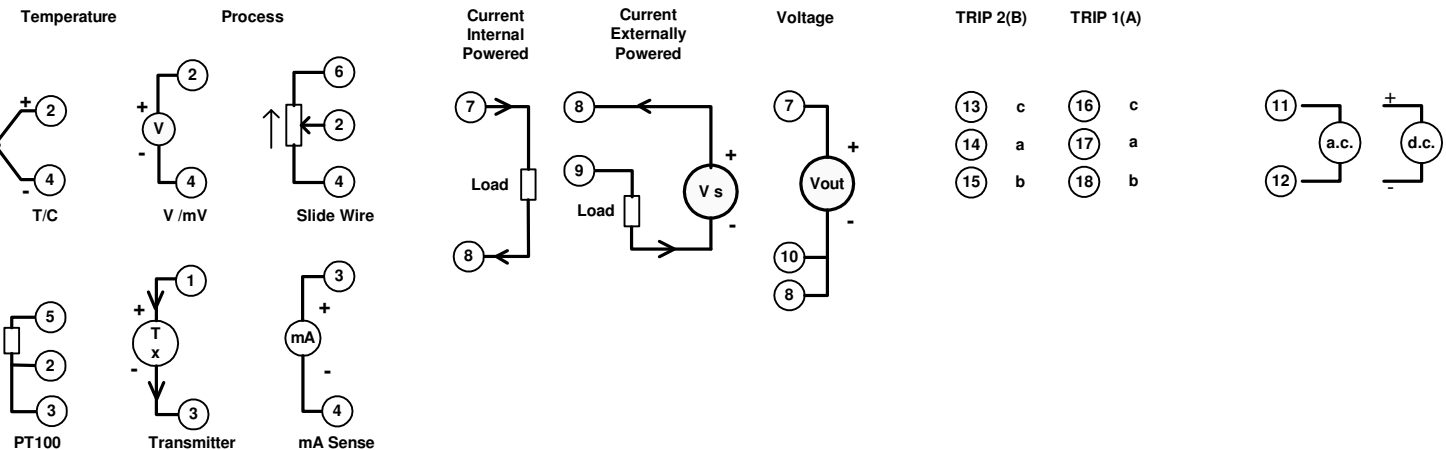

ZTT-50/GD (SEM1700) USER GUIDE

Temperature/Process Conditioner with Universal input, outputs supply plus manual config/trim.



Important - Please read this document before any installing.

Every effort has been taken to ensure the accuracy of this document, however we do not accept responsibility for damage, injury, loss or expense resulting from errors and omissions, and we reserve the right of amendment without notice.

INPUT SUPPLY (20 to 240) V AC or DC OUTPUT

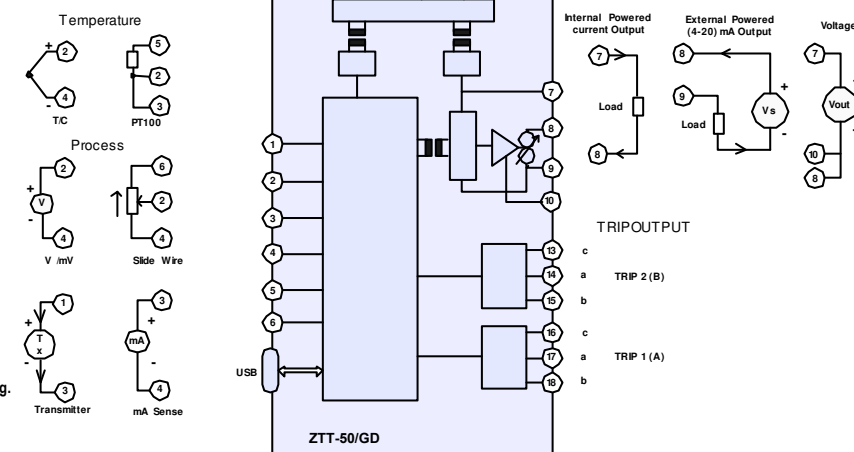

IMPORTANT - CE & SAFETY REQUIREMENTS

This product is suitable for environment Installation category II pollution degree. The product is classed as "PERMANENTLY CONNECTED EQUIPMENT". Product must be DIN rail mounted, inside a suitable enclosure providing environmental protection to IP65 or greater. Dc supply must be derived from a local supply and not a distribution system. Max relay contact rating 240 V AC @ 1 A (30 V DC @ 1A). Any circuit connected to a contact must be fused with a 2 A (T) fuse. To maintain CE EMC requirements , input and supply wires must be less than 30 metres. The product contains no serviceable parts , or internal adjustments. No attempt must be made to repair this product. Faulty units must be returned to supplier for repair. This product must be installed by a qualified person. All electrical wiring must be carried out in accordance with the appropriate regulations for the place of installation. Before attempting any electrical connection work, please ensure all supplies are switched off.

ABSOLUTE MAXIMUM CONDITIONS (To exceed may cause damage to the unit):-

Supply Voltage	± 240 V dc ± 240 V ac (Protected for over voltage)
Input Voltage	± 24 V between any terminals
Input Current	± 50 mA between terminals
Output	30 V dc
Trips	(240 V ac @ 1 A, 30 V dc @ 1 A) non inductive
Ambient	Temperature (-30 to 75) °C Humidity (10 to 95) % RH (Non condensing)
External Supply	1 Amp anti surge fuse recommended

PRODUCT SPECIFICATION

Please refer to the product data sheet for full specification, available to download at www.status.co.uk.

RECEIVE AND UNPACKING

Please inspect the packaging and instrument thoroughly for any signs of transit damage. If the instrument has been damaged, please notify your supplier immediately.

CONFIGURATION

IMPORTANT During configuration the device takes its power from the USB port, therefore no power connection is required. The device can be configured whilst powered but the computer used must be isolated from the mains supply earth to avoid ground loop effects.

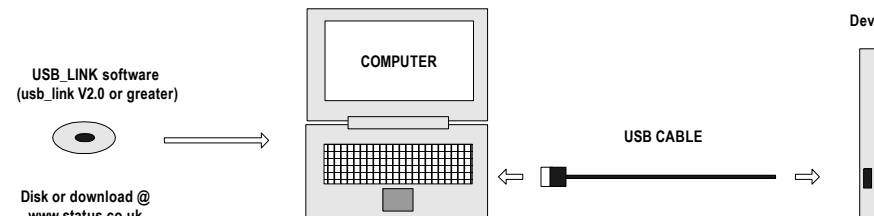

The following parameter can be configured by simply entering as prompted by the software package.

- Input type / input sensor / units (temperature inputs) / sample rate
- Scale input to process variable (process inputs only)
- Analogue Output / Set Type voltage or current / scale output signal range / scale output to process
- Set adjustable damping for both rising and falling output. Set correction for voltage output load.
- Trip Outputs / Set action / Set setpoints / Set deadband / Set adjustable delay on and delay off
- Set burnout direction on sensor failure or input overrange.
- Set the function of the front panel user buttons to off, trim or configure.
- TAG number

Factory default:
Input type = P
Sample rate = 1000 mS
Units = °C
Output = (4 to 20) mA damping 0
High Range = 100
Low Range = 0
Burnout = UPSCALE
User Trim = off
Trips = off, delays 0
Damping = 0

USER TRIM

User trim function allows manual adjustment of the analogue output, this is useful for minor calibration adjustment or trimming out any sensor error, ± 5 % of range adjustment is available at both offset and span. Raise and lower buttons are provided on the front panel, of the transmitter, accessed using a 3 mm flat blade screw driver. Insert the screw driver into the appropriate slot to operate the button. The button has a click action.

The transmitter will automatically detect the correct trim point (offset or span) based on the output signal. Offset will be trimmed when the current is in the offset band, span when the current is in the span band. No trim action occurs at any other current. Note this function needs to be selected by the software configuration tool before use. To lock setting after adjustment the operator can again use the tool to turn this function off, (select the option to save trim when downloading config).

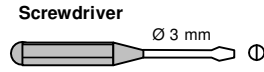

Digital mA meter

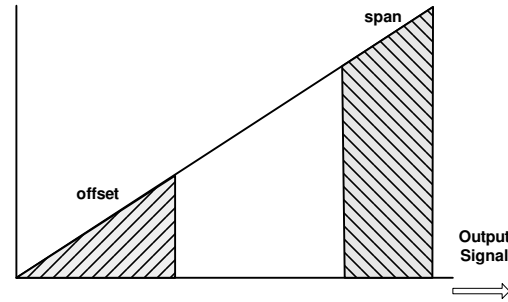

Range	Offset	Span
(4 to 20) mA	(3.8 to 6) mA	(18 to 22) mA
(0 to 20) mA	(0 to 2) mA	(18 to 22) mA
User mA	User low ± 2 mA (Min 0 mA)	User High ± 2 mA (Max 24 mA)
(0 to 10) V	(0 to 1) V	(9 to 11) V
User V	User low ± 1 V (Min 0 V)	User High ± 1 V (Max 12 V)

Supply

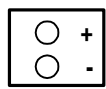

Input Simulator

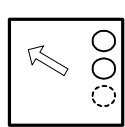

or sensor



METHOD

1.0 Connect transmitter to a suitable input simulator or sensor. Connect supply, connecting a digital meter to monitor output. Turn supply on, set input to offset/span calibration point.
IMPORTANT - IF PERFORMING TWO POINT CAL< ALWAYS CAL OFFSET FIRST.

2.0 Enter trim menu by pressing "raise" button for > two seconds. When the trim menu is open the range LED will flash :-

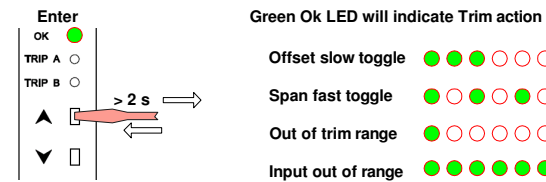

3.0 Trim output current by pressing either the raise or lower button, single click to step advance, or press continuously to auto advance.

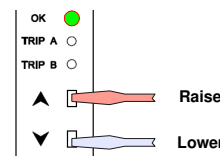

4.0 Once trim is complete allow 30 seconds with no button press, the transmitter will time out and return to normal operation.

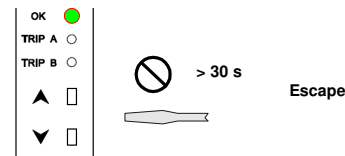

Sensor Fault Conditions

Analogue output. On loss of the input signal the ZTT-50/GD will go into burnout condition, this is selectable (high, low, or user).

Relay output. The relays will trip (change state from the normal condition) on loss of the input signal, unless set to the off position.

Process Input. Analogue output. Loss of the input signal does not effect the output in the same way as with TC or RTD. With process inputs a lost signal will be seen as a process value scaled to the equivalent of a zero electrical input. If the process value is below the process low range the output will go to its low scale value (less approximately 10% of the output range)

Relay output. Only with low alarm or low control will the relays trip (change state from the normal condition) on under range/loss of input signal.

USER RANGE CONFIGURATION

This function allows two point manual configuration of the re-transmission current (voltage) at low and high range against a live input signal. This is useful for on-site configuration, example with a slide wire input the user manually positions the slide at both low and high positions and configure the unit to operate over the range. Configuration is achieved using either the raise (span) or lower (offset) buttons. To operate this function must first be selected using the software configuration tool. The operator may lock this function (once set) by turning off the function.

Screwdriver

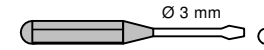

METHOD

1.0 Connect transmitter to a suitable input simulator or sensor. Connect supply, turn supply on, set input to either offset or span calibration point.

2.0 To enter configuration, set input to desired high or low setting and wait 10 seconds. Press and hold raise (high) or lower (low) button on for > 2 s to enter.

3.0 Once the menu has been entered, quickly (within 1 second) apply a single press to the raise (high) or lower (low) button to store setting. To abort configuration, allow config to time out by not pressing buttons for 5 seconds.

The ok LED will then start to flash at a slow rate (low) or fast rate (high).

Input Simulator

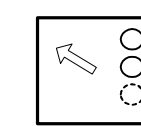

or sensor

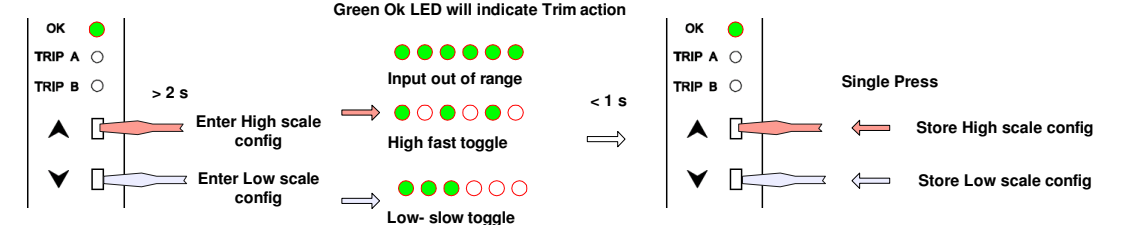

OUTPUT DAMPING

User adjustable damping of the analogue output is provided for both rising and falling signals. The adjustable range is (0 to 250) second for a (0 to 20) mA or (0 to 10) V swing. To calculate the maximum rate of change of the output signal divide 20 mA (10 V) by the damping setting, example if the damping is set to 100 seconds the mA output will change at a maximum rate of (20/100) = 0.2 mA /Second. Use USB_LINK software to configure damping setting.

TRIP OUTPUTS

Dual trip change over contacts are available. The contacts are rated at 240 V ac 1 A (Non inductive) 30 V DC 1 A. An external snubber network is recommended when switching inductive circuits. Please ensure the snubber network is rated for the application. Four actions are provided, as detailed in the diagram below. The Alarm actions may also be used for inverted control applications, example the high alarm action can be used to control a cooling fan when used to control the temperature of a heat source. Adjustable setpoint and deadband are provided together with adjustable on and off delays for each trip. The delay range is (0 to 250) Seconds.

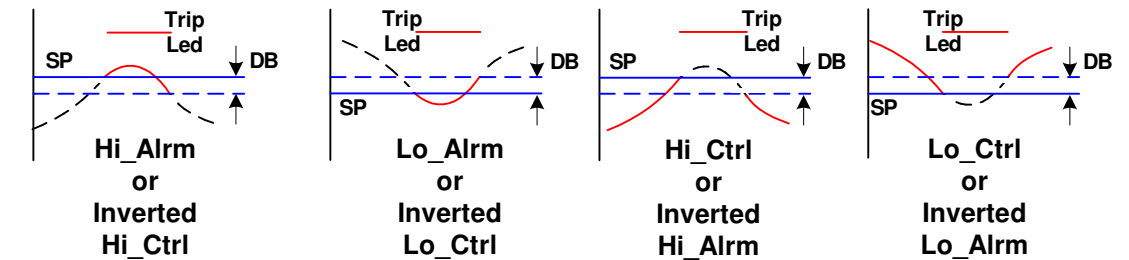

Action	Normal	Trip	Temperature Range Error	Power off
Hi_Alm / Inverted Hi-Ctrl	A-C, B-C	A-C, B-C	A-C, B-C	A-C, B-C
Lo_Alm / Inverted Hi-Ctrl	A-C, B-C	A-C, B-C	A-C, B-C	A-C, B-C
Hi_Ctrl / Inverted Hi_Alm	A-C, B-C	A-C, B-C	A-C, B-C	A-C, B-C
Lo_Ctrl / Inverted Lo_Alm	A-C, B-C	A-C, B-C	A-C, B-C	A-C, B-C

